

# ELGO

Kit for CPx series compression load cells, for weighing silos, tanks and high-capacity hoppers.





# CONTENTS

<b>1.</b>	<b>INTRODUCTION</b>	<b>4</b>
	Main parts and functions	4
	Applications	5
	Technical features	8
	Dimensions	9
<b>2.</b>	<b>INSTALLATION</b>	<b>12</b>
	Installing the kit	12
	Installation tips	13
	Expansion compensation	15
	Using dummy load cells	16
	Tensioners for lateral forces	18
	Earth connection	19

# INTRODUCTION

The ELGO kit is a mechanically assembly made entirely of STAINLESS STEEL, designed to speed up, simplify and customise the installation of CPx series compression load cells up to 12500 kg under silos, hoppers, tanks and rigid structures in general, in harsh work environments or in an environment with strict hygiene requirements.

The ELGO kit is designed and engineered for optimal weighing results, compensating for lateral or transverse parasitic forces making it adaptable to many applications.

In addition, its intuitive structure facilitates assembly and maintenance.

## MAIN PARTS AND FUNCTIONS

The kit consists of two elements: ELGOC and ELGOP.

### ■ ELGOP

ELGOP is the plate that facilitates mounting the kit to the weighing structure.

### ■ ELGOC

ELGOC is the multipurpose modular attachment that allows you to:

- Position and secure the load cell correctly.
- Compensate the expansions of the weighing structure.
- Adjust the height of the kit according to the requirements.
- Pair two load cells at each weighing point to set up double safety systems.

### ■ ELGON

ELGON is a stainless steel load button placed in the central housing of ELGOC for the latter to assume the exact dimensions of a CPx load cell. In this way, ELGOC also has a dummy load cell function.

### BENEFITS

- Installation and rapid maintenance of the load cell
- Elimination or reduction of any friction between the upper and lower structure
- The modularity allows various functional combinations in different applications

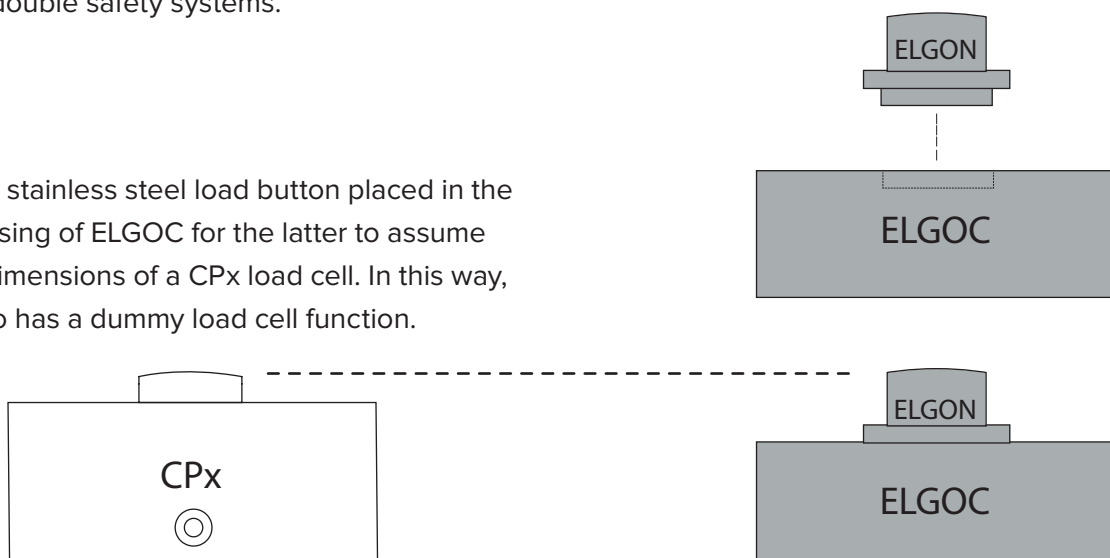

# APPLICATIONS

N.B. ELGO has no anti-tilting function.

The installer must provide a proper anti-tilting system, sized according to the weighing structure.

## ■ 1. BASIC CONFIGURATION

The basic configuration, which is extremely compact, requires an ELGOP and ELGOC and offers the advantage of quick and intuitive assembly.

fig 1.1

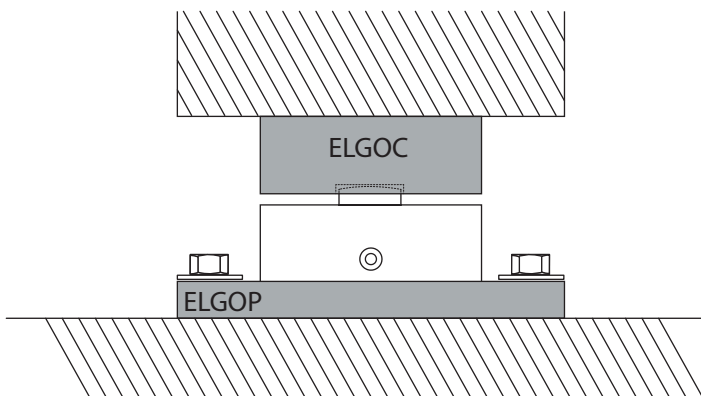
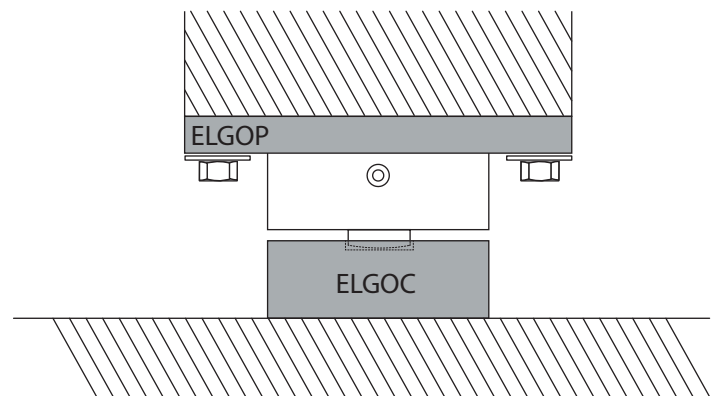

fig 1.2



## ■ 2. CONFIGURATION WITH A REMOVABLE CELL

It can be integrated with ELGOC without other fasteners by placing special grub screws in the threaded holes of the cell.

In this way the assembly and maintenance of the cell is much easier and quicker.

This configuration also prevents rotational movement of the cell.

fig 2.1

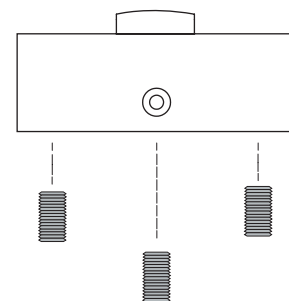

fig 2.2

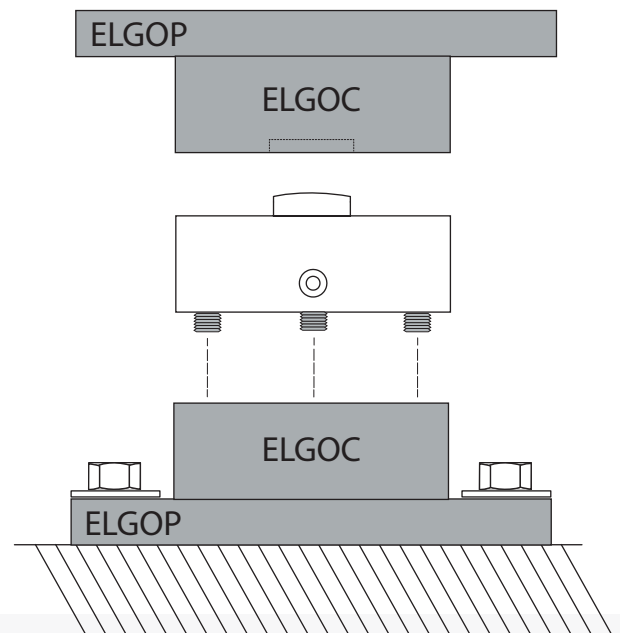
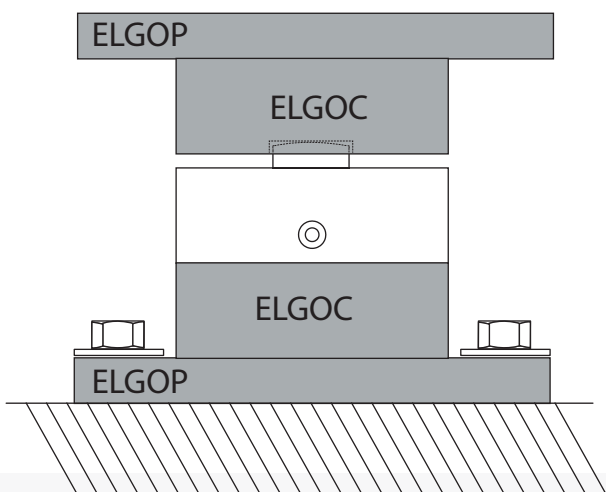

fig 2.3



### ■ 3.PROTECTION FROM DIRT

In harsh environments in which the cell is in contact with processing residue, it can be raised by installing two or more ELGOC, reaching sufficient height to protect it.

This assembly also offers the advantage of installing the cell at the suitable height to facilitate maintenance and wiring.

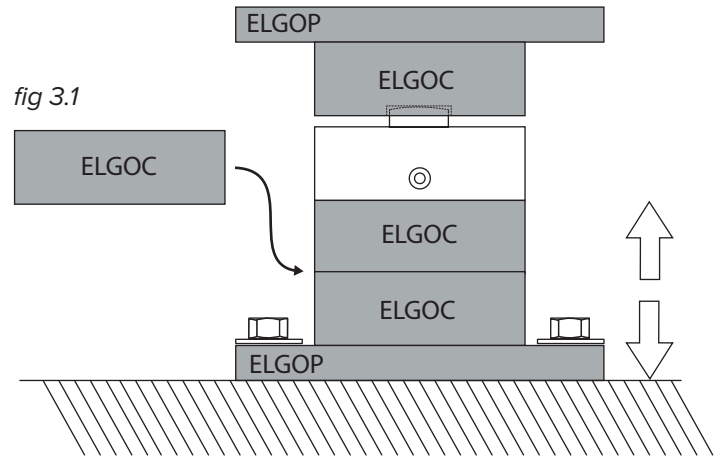

### ■ 4.CONFIGURING A DOUBLE CELL FOR INCREASED SAFETY SYSTEMS

The kit, in combination with a multi-channel Dini Argeo indicator, allows 2 cells to be assembled in each weighing point, thereby offering two advantages:

- Double reading of the same weight for constant verification that the weighing system is working correctly.
- In case of an accidental fault, continue to weigh without interruption.

fig 4.2

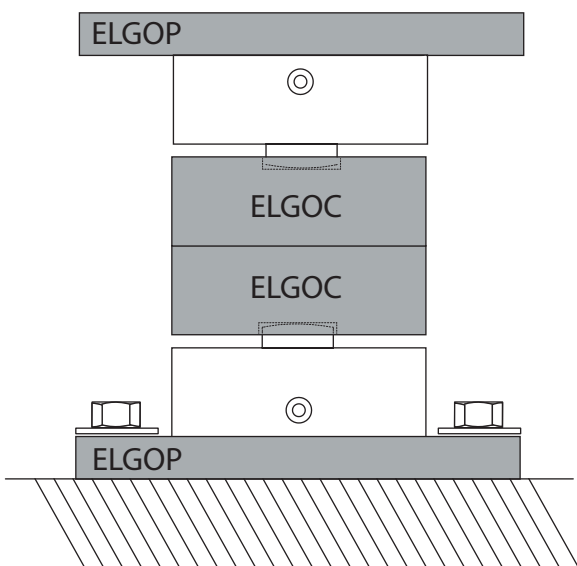
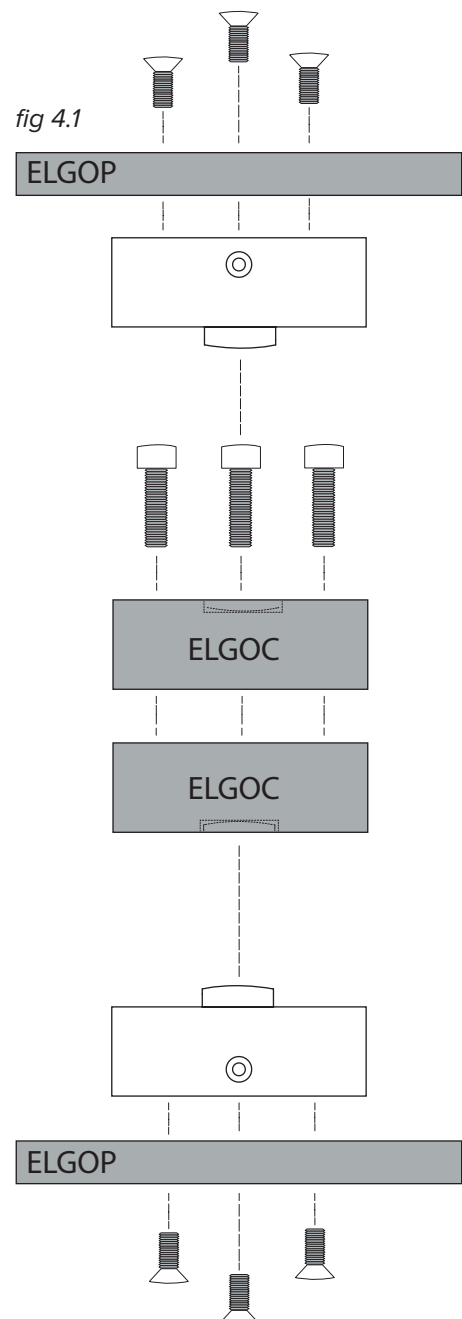

fig 4.1



## ■ 5.REVERSE ASSEMBLY

Many assembly combinations implemented with the ELGO kit can be reversed, depending on the installation and maintenance requirements.

fig 5.1

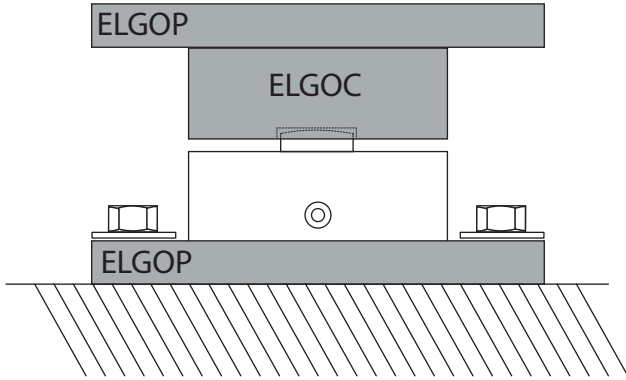









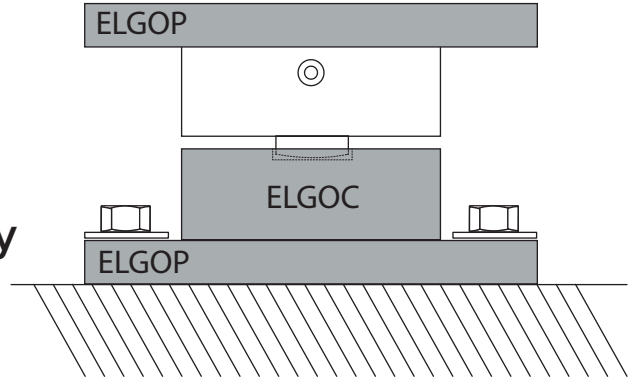

reverse  
  
assembly

fig 5.2



# TECHNICAL FEATURES

		ELGOC	ELGOP
<b>COMPATIBLE LOAD CELLS</b>		CP/CPX SERIES UP TO 12500 kg	
<b>MATERIAL</b>		STAINLESS STEEL AISI304	
<b>WEIGHT (kg)</b>	WITH LOAD CELL	2.2	2
	WITHOUT LOAD CELL	1.2	1
<b>SAFETY LOAD IN COMPRESSION</b>	 WITH LOAD CELL	120% F.S.	
	 WITHOUT LOAD CELL	120% F.S.	
<b>BREAKING LOAD IN COMPRESSION</b>	 WITH LOAD CELL	300% F.S.	
	 WITHOUT LOAD CELL	30000 kg	
<b>SAFETY LOAD IN TRACTION</b>	 WITH LOAD CELL	-	-
	 WITHOUT LOAD CELL	-	-
<b>BREAKING LOAD IN TRACTION</b>	 WITH LOAD CELL	-	-
	 WITHOUT LOAD CELL	-	-
<b>MAXIMUM ANGLE OF THE SUPPORTING LEVEL</b>			
<b>EXPANSION COMPENSATION</b>		+/- 2.5 mm	+/- 2.5 mm
		+/- 2.5 mm	+/- 2.5 mm
<b>ATEX EX MARKING (upon request)</b>		ATEX II 2GD c IIC T6 85°C	



# DIMENSIONS in mm

## ■ 1.ELGOC

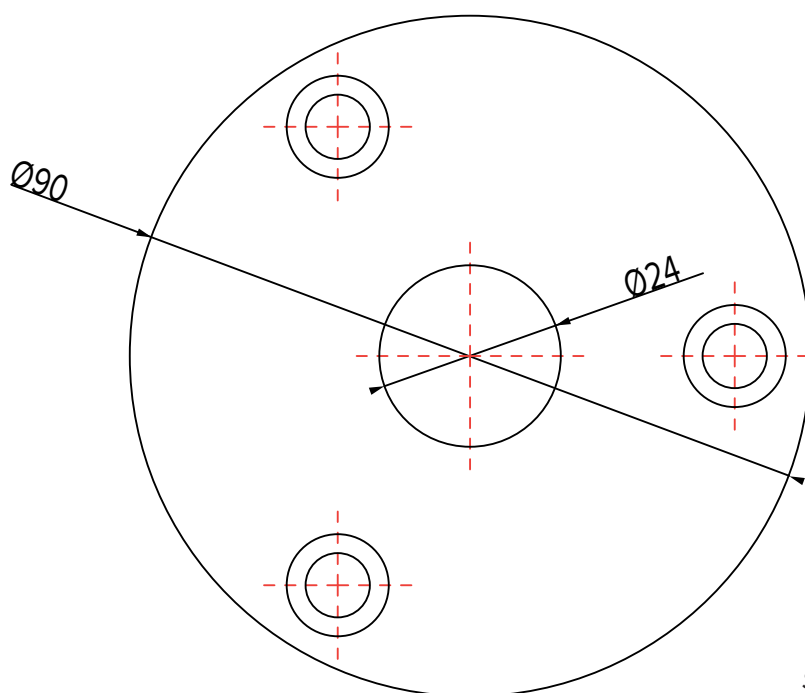
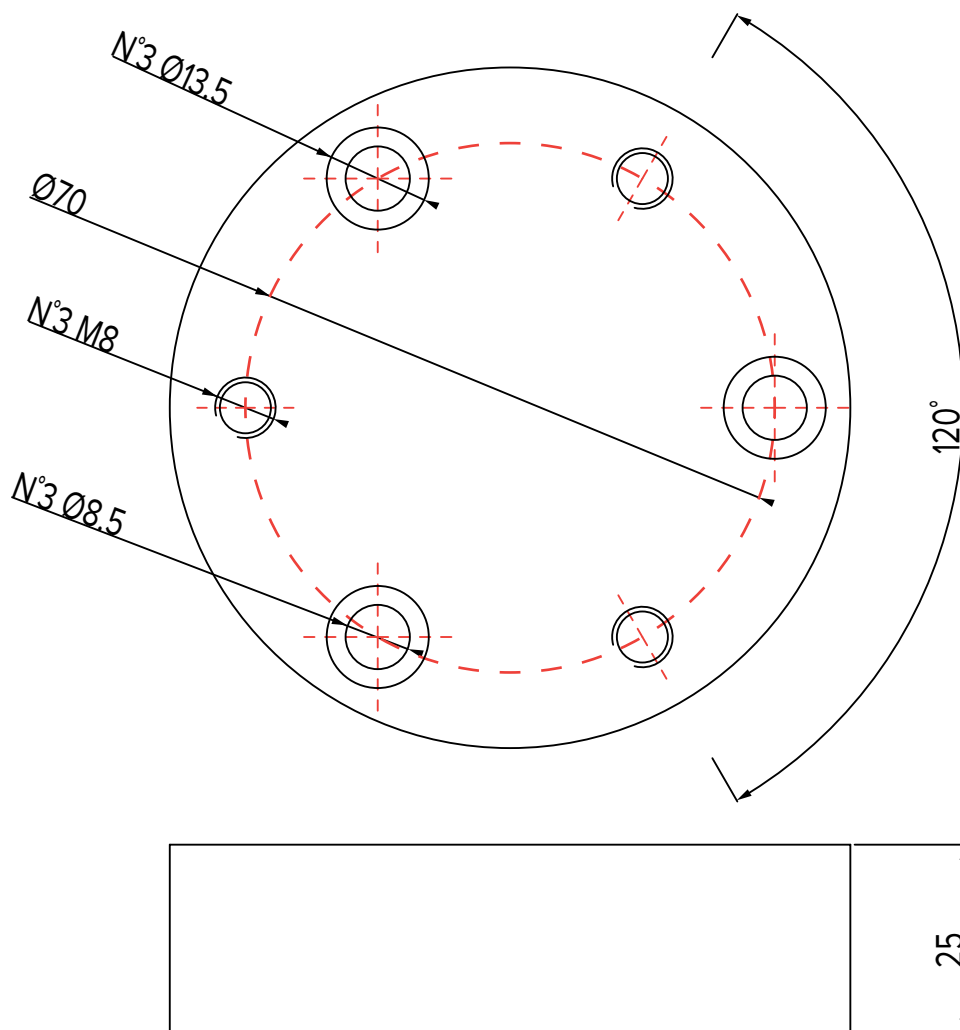

SCALE 1:1

■ 2.ELGOP

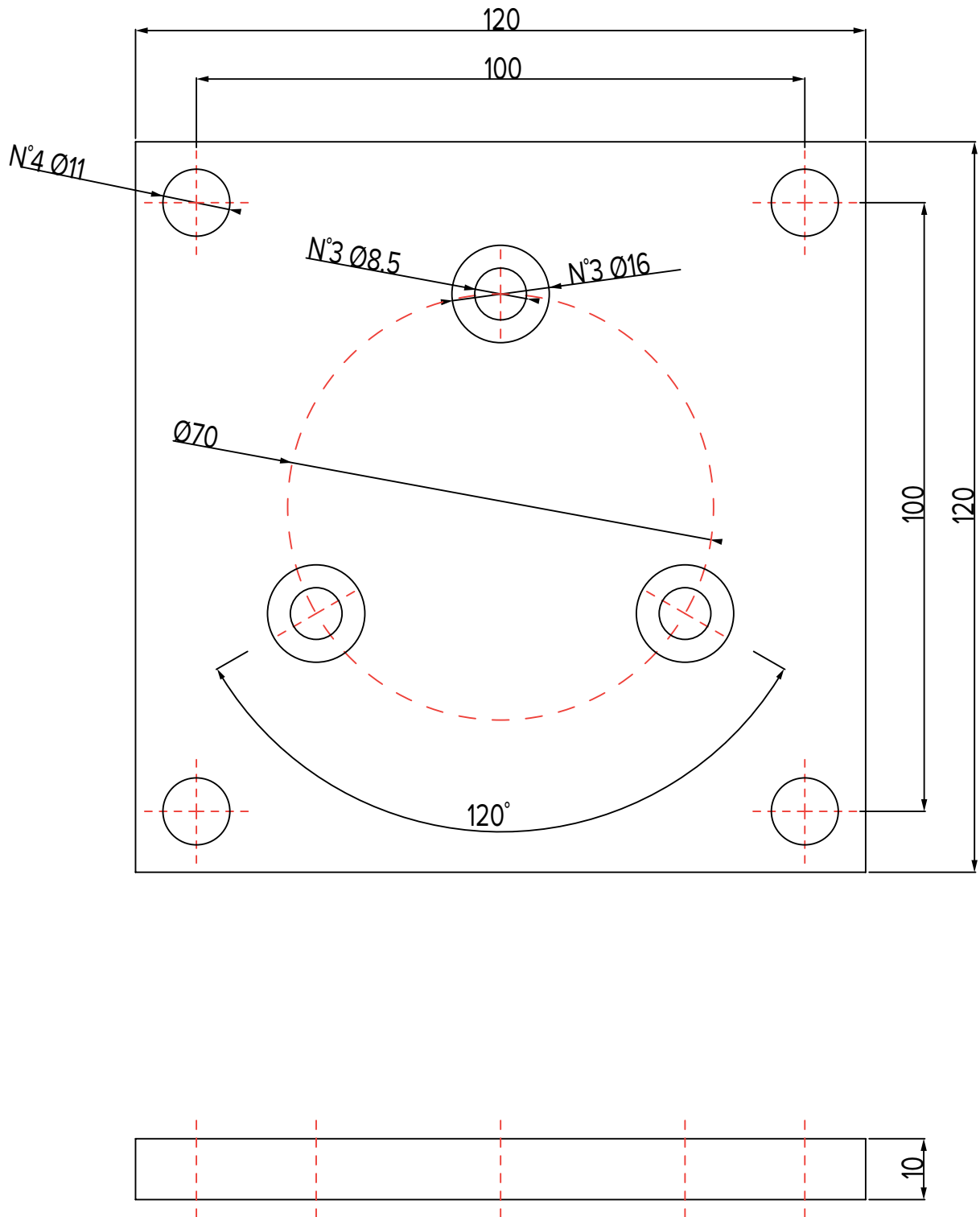

SCALE 1:1

■ 3.ELGON

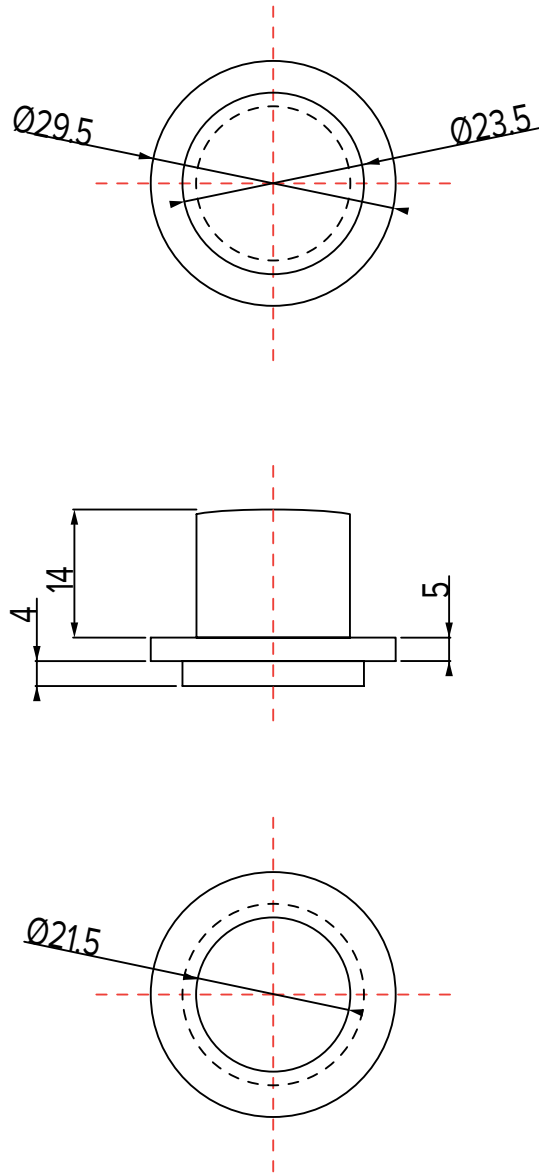

SCALE 1:1

# INSTALLATION

## INSTALLING THE KIT

Use a hydraulic jack of adequate capacity, a spanner for M10 hex screws and Allen keys size 5 and 6 for the installation.

### 1. GUIDE TO ASSEMBLE THE KIT

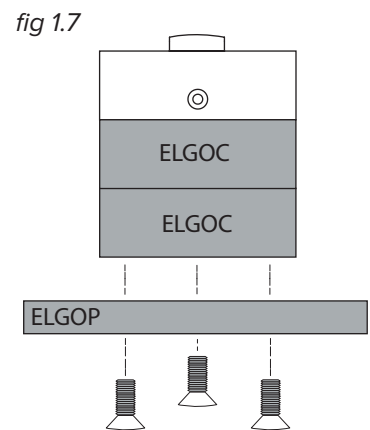
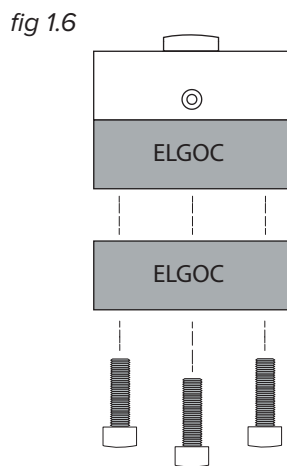
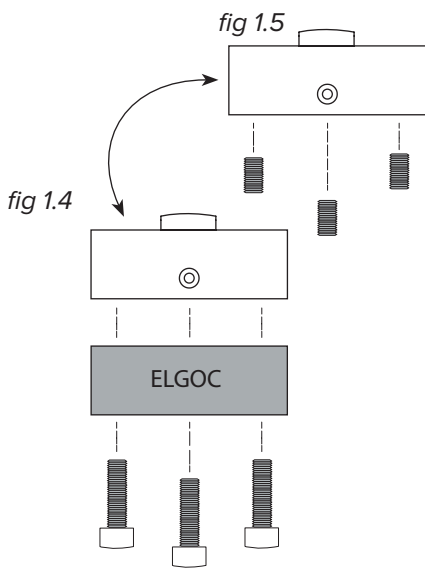
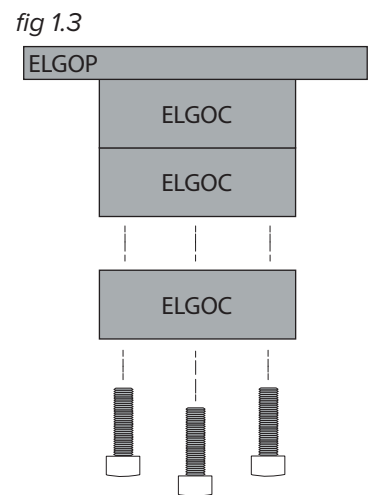
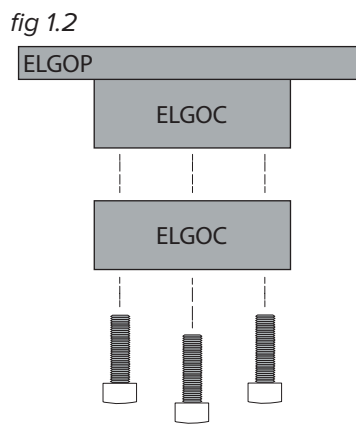
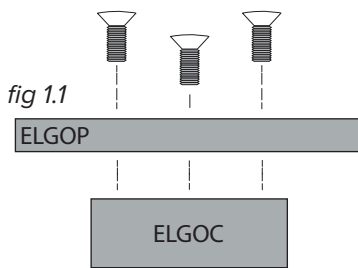

fig 1.1 - assembling ELGOP over ELGOC.

fig 1.2/1.3 - assembling several ELGOC.

fig 1.4 - fixed assembly of ELGOC to a CPx load cell.

fig 1.5 - mobile assembly of ELGOC to a CPx load cell.

fig 1.6 - assembling several supporting ELGOP.

fig 1.7 - assembling the ELGOP below ELGOC and cells.

# INSTALLATION TIPS

## SUPPORTING BASIC FEATURES

The supporting base of the weighing kit must be extremely rigid and must have a suitable surface and thickness to ensure the lower plate of the ELGO kit works properly.

Calculate the thickness  $h_2$  according to the precision, the structure to be supported and the environmental conditions.

You may want to consider the following, at least

$$h_2 \geq h_1 \quad \text{and} \quad l_2 \geq l_1$$

Recommended dimensions:

<b>ELGOC</b>	$h_2 \geq 25 \text{ mm}$	$l_2 \geq 90 \times 90 \text{ mm}$
<b>ELGOP</b>	$h_2 \geq 10 \text{ mm}$	$l_2 \geq 120 \times 120 \text{ mm}$

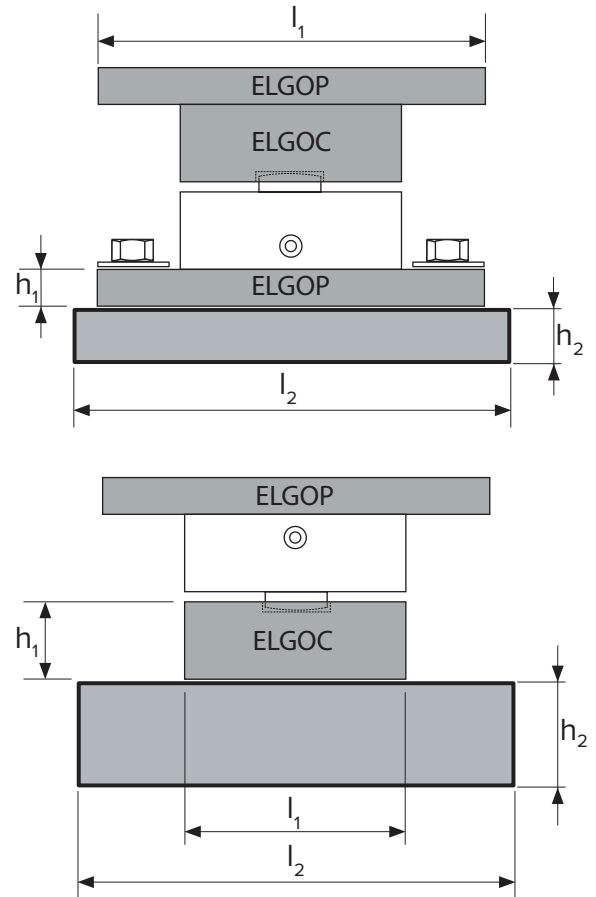

## TO BE AVOIDED

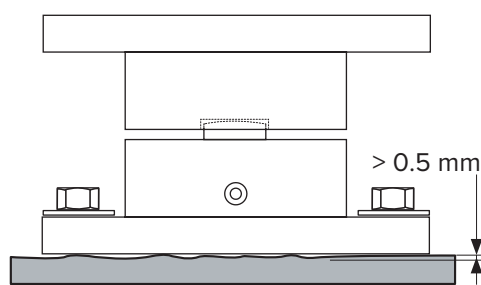

Irregular surfaces with roughness greater than 0.5 mm.

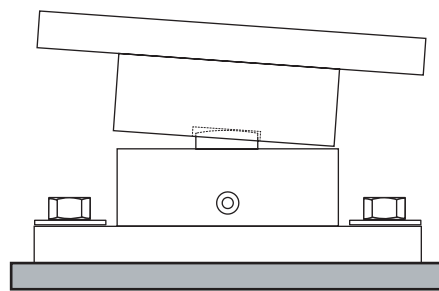

Top plate and bottom plate inclined over the limits allowed.

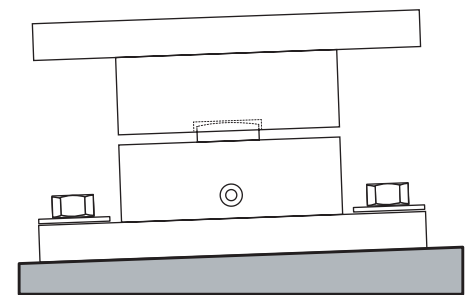

Inclined surfaces over the limits allowed.

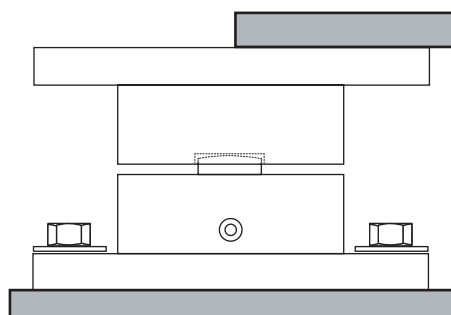

Misaligned load.

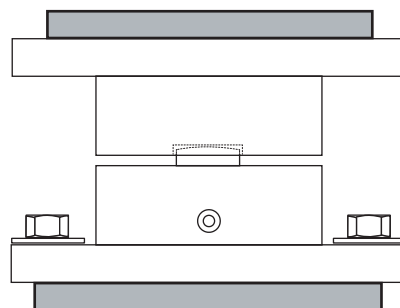

Supporting base of the kit is too thin and/or short.

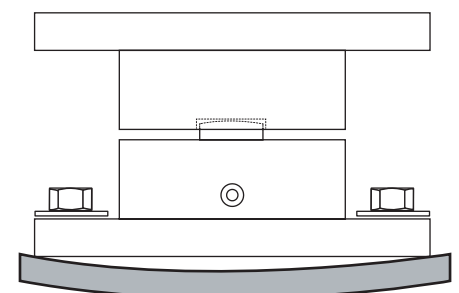

Non-rigid supporting bases, which can deform under a load.

## ■ ANTI-TILTING SOLUTION

The ELGO kit does not have a anti-tilting function for the forces referred to in the table on page 8.

Depending on the application, the forces in question, the atmospheric and environmental conditions, the designer can increase the protection of the weighing

structure by adding adequately sized anti-tilting systems. It is good practice to adjust the system so as to leave a stroke of no more than 2 mm.

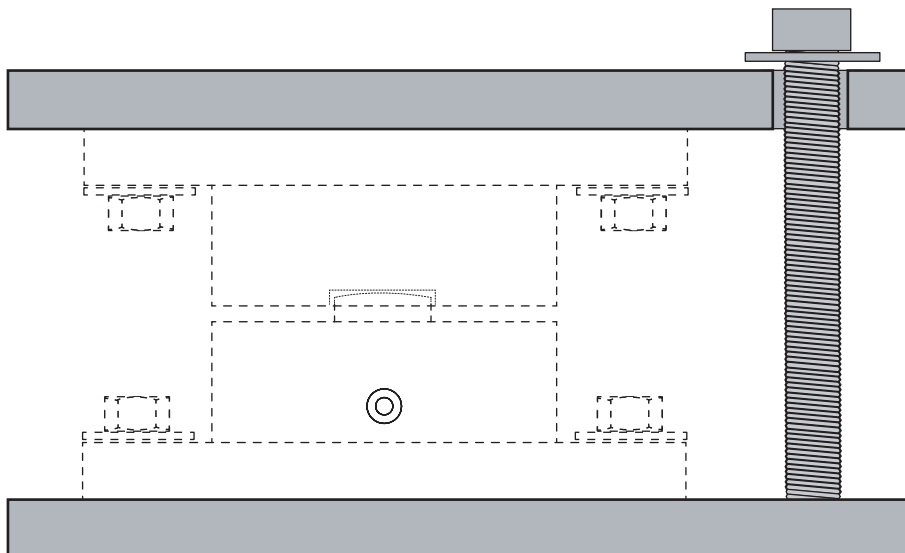

*Example layout of anti-tilting solution.*

# EXPANSION COMPENSATION

## HORIZONTAL AND VERTICAL SILOS WITH 4 OR 3 FEET

### Typical applications

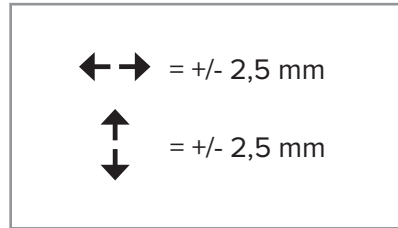

### Horizontal silos

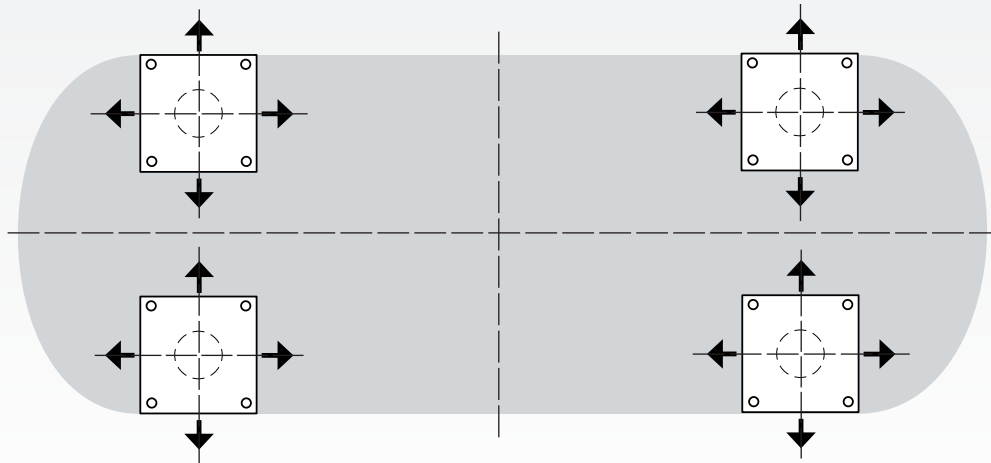

### Vertical silos with 4 feet

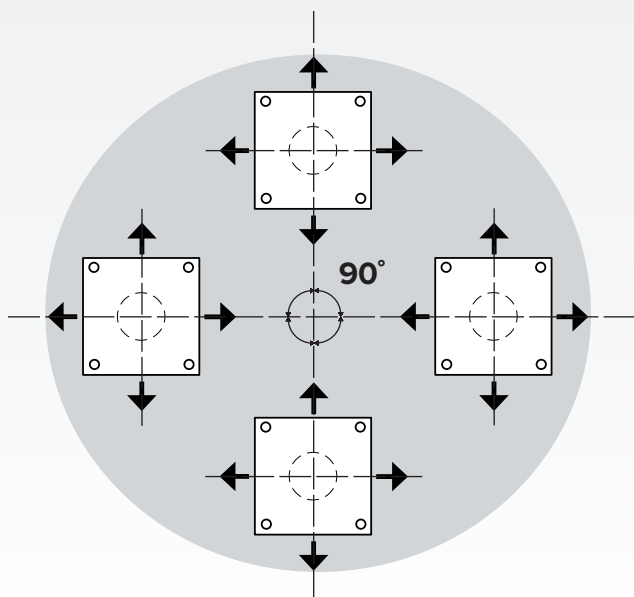

### Vertical silos with 3 feet

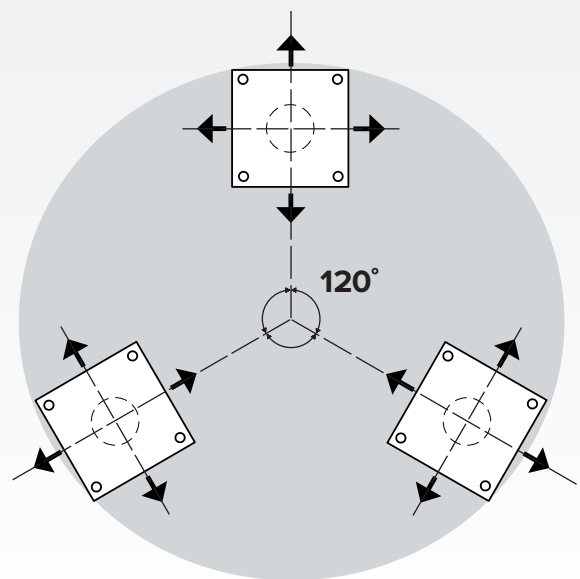

# USING DUMMY LOAD CELLS

Applicable solution to measure levels and the weight of fluids and liquefied gases.

This involves the use of a single ELGO weighing kit with a load cell and  $n$  ELGO kits equipped with the ELGON accessory, which support the weighing structure and allow the load cells to be added later so as to increase precision.

## BENEFITS

- Reasonable price
- Speed of installation

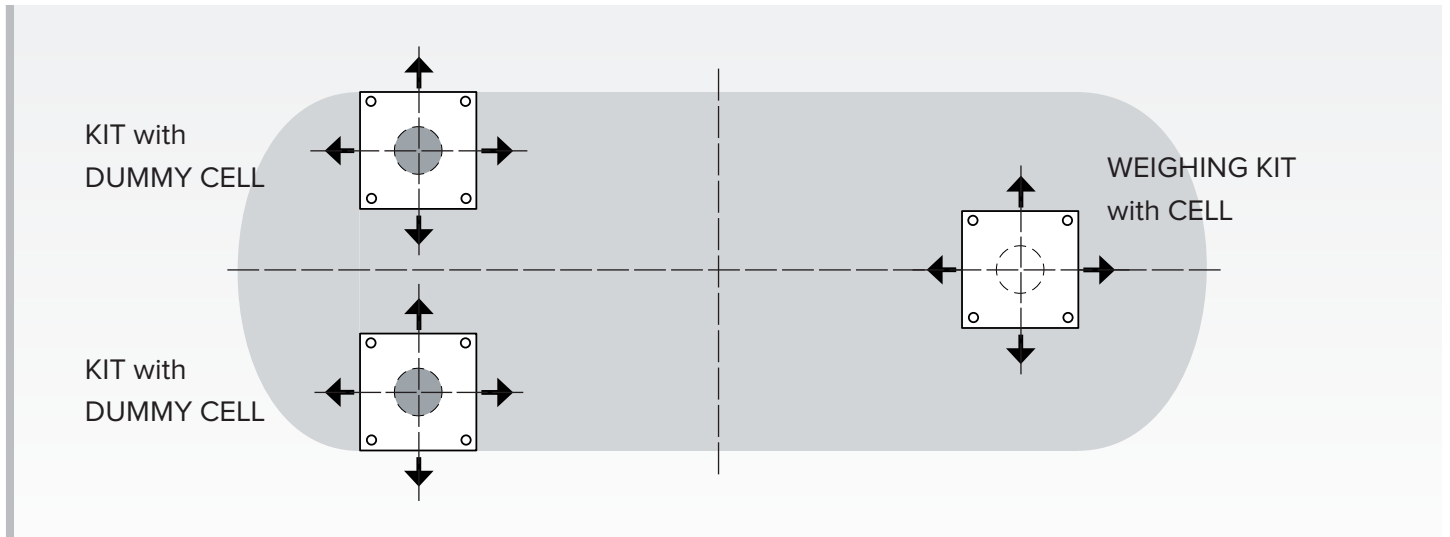

Perform the theoretical calibration with Dini Argeo indicator, by setting:

$CEL.CAP$  = capacity of the load cell x 2

$CEL.SE_n$  = nominal signal of the cell (for example 2mV/V)

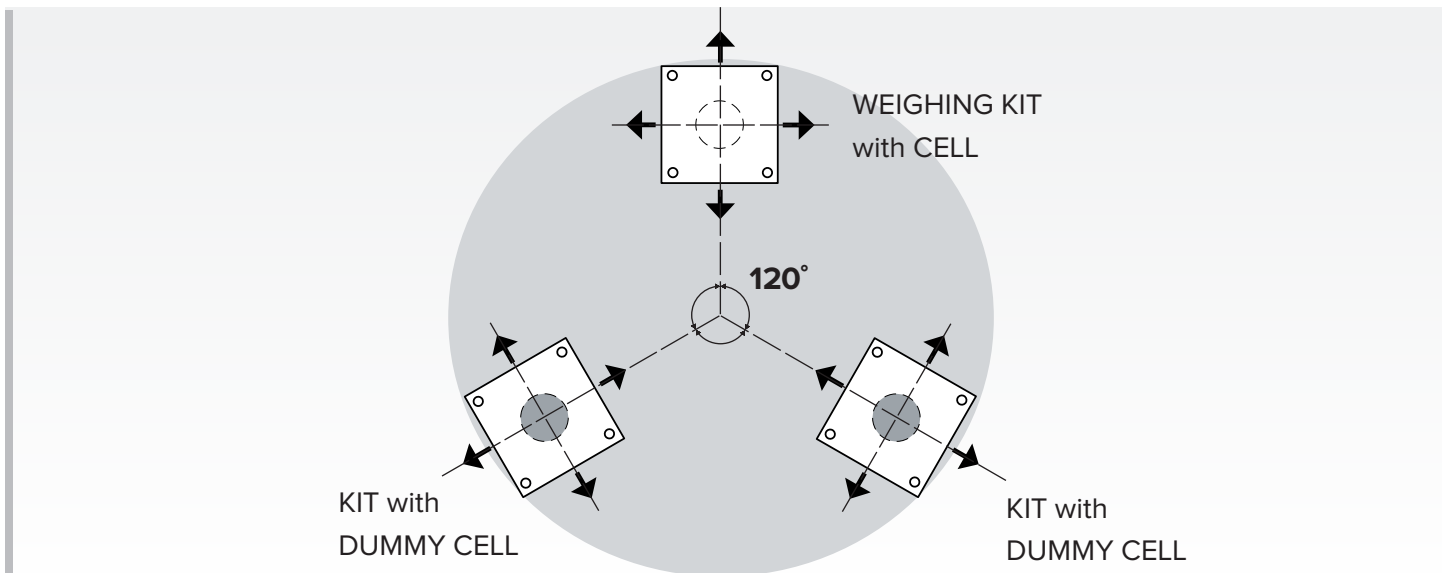

Perform the theoretical calibration with Dini Argeo indicator, by setting:

$CEL.CAP$  = capacity of the load cell x 3

$CEL.SE_n$  = nominal signal of the cell (for example 2mV/V)



## ■ EXAMPLE OF A DUMMY LOAD CELL

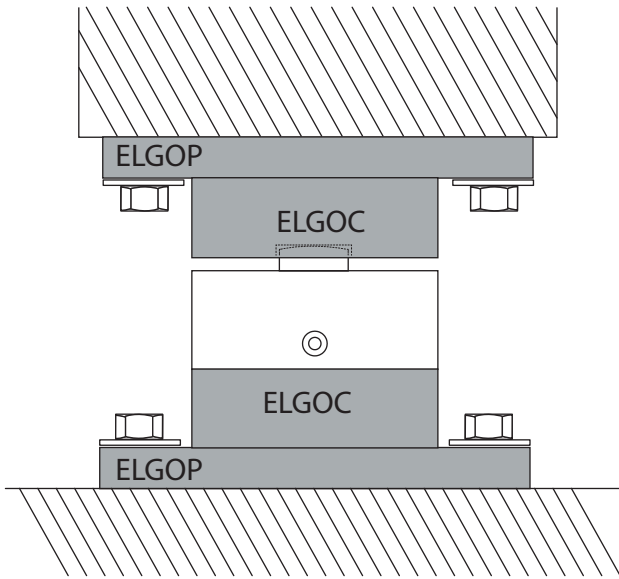

ELGO kit with CPx load cell.

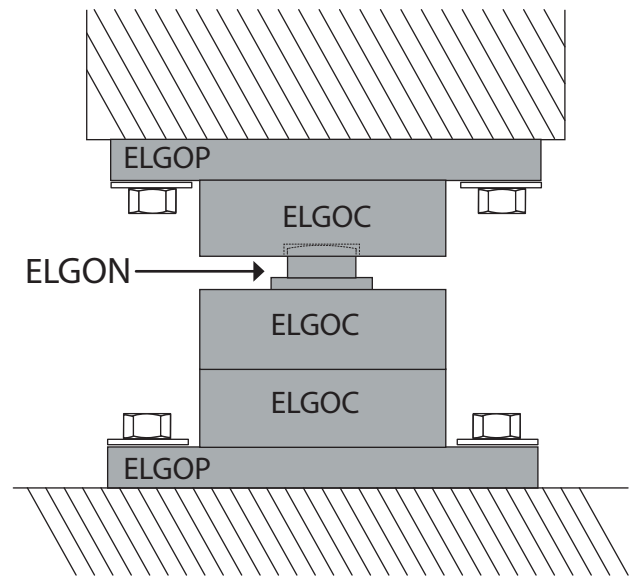

ELGO kit with dummy load cell composed of ELGOC and ELGON instead of the CPx compression load cell.

# TENSIONERS FOR LATERAL FORCES

Ideal to counter any lateral forces such as wind, expansions and accidental impacts that could affect the operation of the weighing kit.

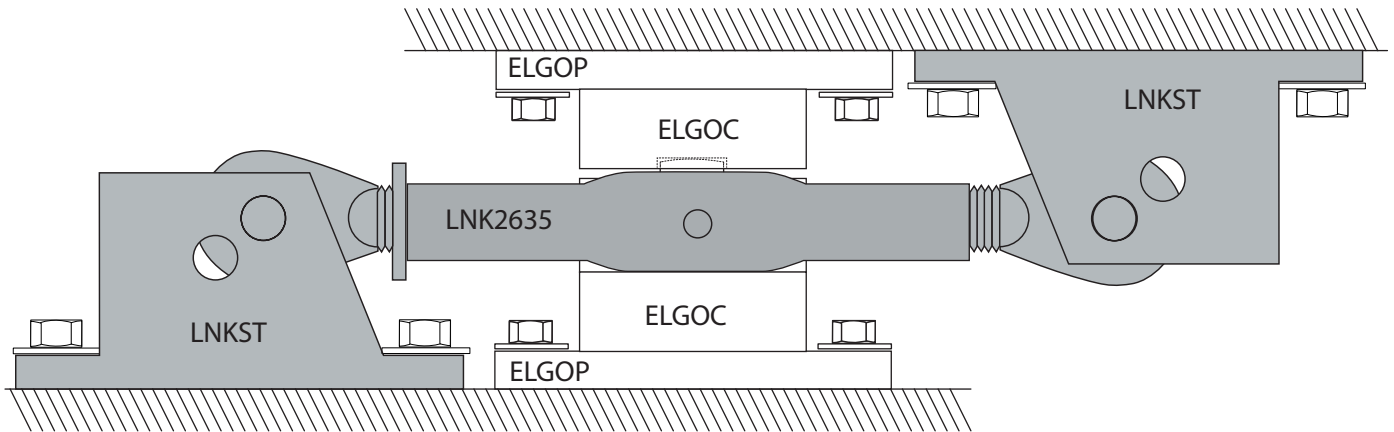

## Examples of layout

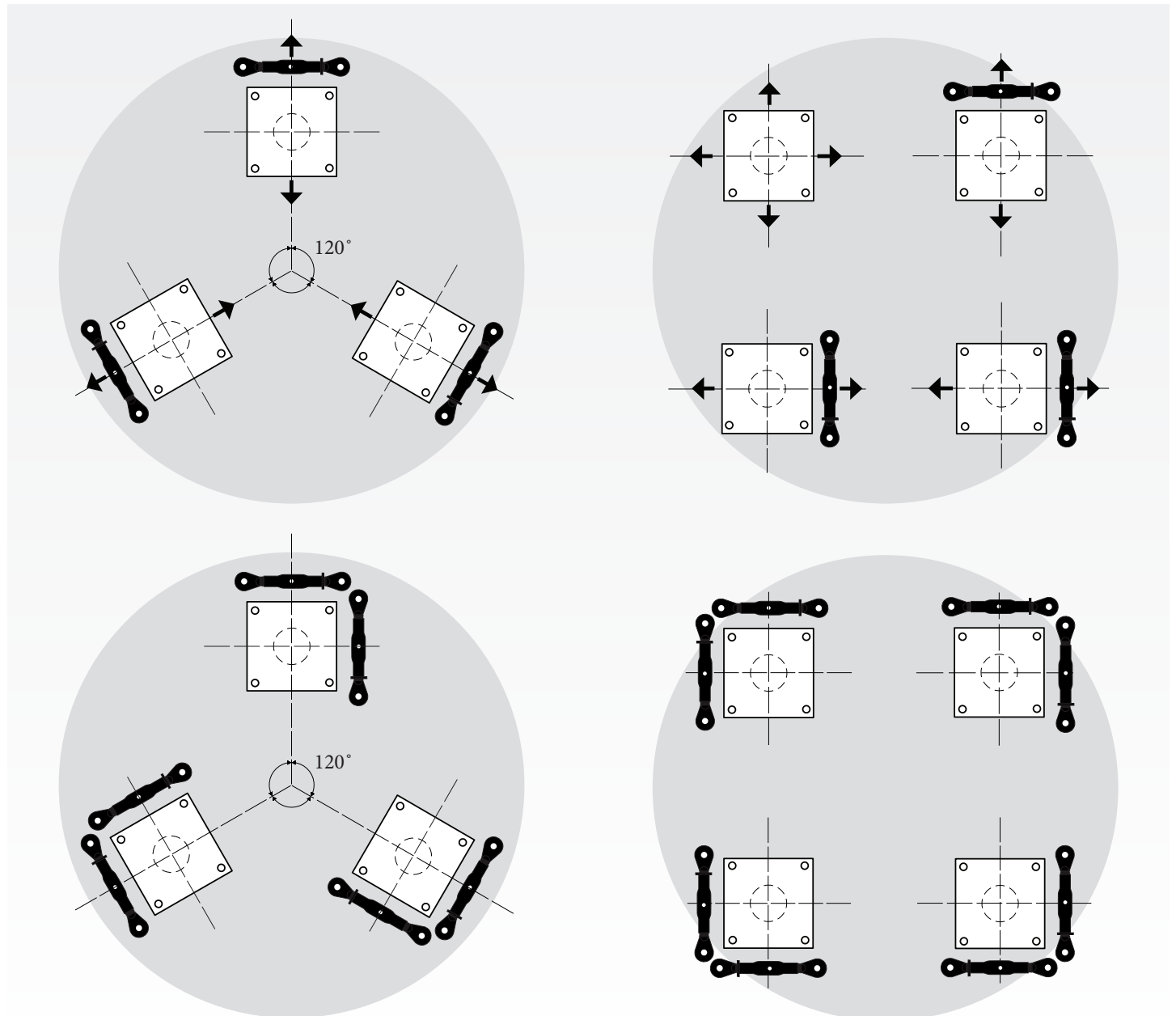

# EARTH CONNECTION

It is recommended to connect the earth of each weighing kit properly so as to protect the load cell from parasitic electrostatic discharge:

For environments with high probability of the formation of electrostatic discharge (presence of dust, plastics, synthetic substances, etc.), it is recommended to create a bypass between the top plate and bottom plate:

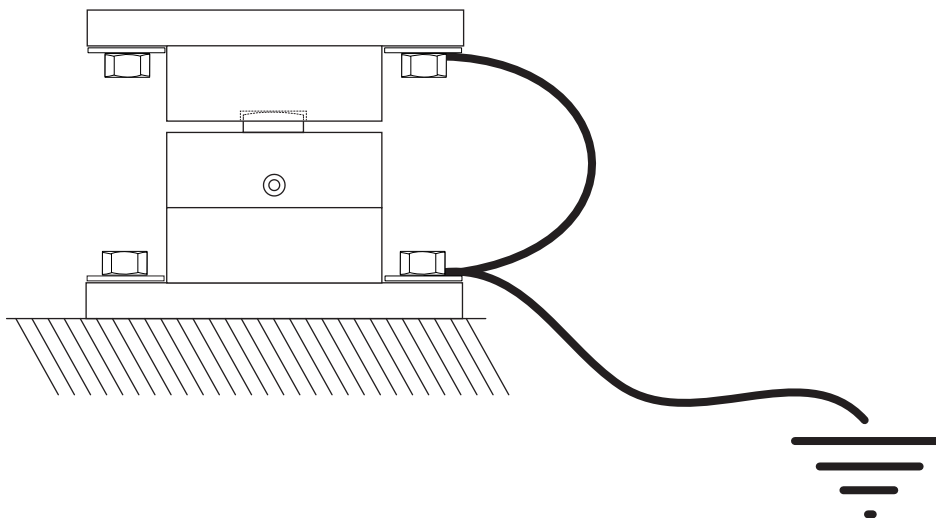

## ■ CABLE SECTION

We recommend using a cable of adequate section to withstand the electrical discharges but no less than 16 mm<sup>2</sup>.

Use an eyelet terminal of adequate diameter to connect the cable to the kit.



#### **HEAD OFFICE**

Via Della Fisica, 20

41042 Spezzano di Fiorano, Modena - Italy

Tel. +39.0536 843418 - Fax. +39.0536 843521

info@diniargeo.com

#### **SERVICE ASSISTANCE**

Via Dell'Elettronica, 15

41042 Spezzano di Fiorano, Modena - Italy

Tel. +39.0536 921784 - Fax. +39.0536 926654

service@diniargeo.com